



www.r-techwelding.co.uk
email: salesdept@r-techwelding.co.uk
Tel: 01452 733933 Fax 01452 733939

R-TECH MIG251 MIG WELDER

OPERATION INSTRUCTIONS



Version 2023-11

Thank you for selecting the R-Tech MIG251 Digital Inverter MIG Welder.

The MIG251 Digital has many benefits over traditional MIG welders, including EASY SETUP, infinite power control and spool gun option for easy aluminium welding.

We want you to take pride in operating our MIG251 Digital as much pride as we have taken in making this product for you. Please read all information in this manual before operation

PLEASE EXAMINE CARTON AND EQUIPMENT FOR DAMAGE IMMEDIATELY

When this equipment is shipped, title passes to the purchaser upon receipt from the courier. Consequently all claims for material damaged in shipment must be made by purchaser against the transportation company used.

Please record your equipment identification below for future reference. This information can be found on data plate at rear of machine.

Product: MIG251 Digital MIG Welder

Serial No. _____

Date of Purchase _____

Where Purchased _____

Whenever you request replacement parts or information on this equipment please always supply information you have recorded above

Pay particular attention to the safety instructions we have provided you for your protection The level of seriousness to be applied to each section is explained below



This statement appears where the information must be followed exactly to avoid serious personal injury.

CAUTION

This statement appears where the information must be following to avoid a minor personal injury or damage to this equipment.

Introduction

The R-Tech MIG251 welder is a member of our field acclaimed family of welding machines.

Premium features include

Digital screen with EASY SET

35% Industrial duty cycle

Inverter power source - more efficient

Quiet fan cooling system

Spool gun option

MMA Stick welder

Lightweight and portable

Euro type torch fittings for easy torch fitment/replacement

EASY SETUP MIG and MMA

Professional MIG weld settings built in using 0.6/0.8/1.0mm wire, flux cored wire and MMA settings for 6013/7018 electrode.

Simple to use easy navigation - no complicated menus - all settings on single screen.

Trim control to fine tune weld power and wire speed.

MANUAL MIG MODE

Infinite welding voltage to allow fine tuning of weld characteristics

2T, 4T Trigger modes

Burnback control

Spool gun facility - Easy aluminium welding

Welding Capability – Duty Cycle

The R-Tech MIG251 Digital is rated at 250 Amps at 35% duty cycle on a ten minute basis.

If the duty cycle is exceeded a thermal protector will shut machine off until the machine cools.

Safety Precautions

Read entire section before starting installation.

Warning!



Electric Shock can kill – Only qualified personnel should perform this installation. Turn off input power at the fuse box before working on this equipment. Do not touch electrically live parts. Always connect the machine to an earthed mains supply as per national recommended standards.

Select suitable location

Place the welder where clean cooling air can freely circulate in and out of the front & rear louver vents. Dirt, dust or any foreign material that can be drawn through vents into welder must be kept to a minimum. Failure to observe these precautions can result in excessive operating temperatures which can lead to plant failure.

Grinding

Do not direct grinding particles towards the welder.
An abundance of conductive material can cause plant failure.

Transport & unloading

Never underestimate the weight of equipment, never move or leave suspended in the air above people.
Use recommended lifting/handling equipment at all times.

Electrical installation

WARNING ELECTRIC SHOCK CAN KILL



Electric Shock can kill – Only qualified personnel should perform this installation. Turn off input power at the fuse box before working on this equipment. Do not touch electrically live parts. Always connect the machine to an earthed mains supply as per national recommended standards.

Machine grounding and Interference Protection

This welder must be grounded to earth. See national electrical codes for proper grounding methods.

The high frequency generator being similar to a radio transmitter may cause interference to radio, TV and other electronic equipment. These problems may be the result of radiated interference.

Proper grounding methods can reduce or eliminate this.

Radiated interference can develop in the following ways

1. Direct interference from welder power source
2. Direct interference from the welding leads
3. Direct interference radiated from feedback into power lines
4. Interference from re-radiation by un-grounded metallic objects.

Keeping these contributing factors in mind, installing equipment as per following instructions should minimize problems.

1. Keep the welder input power lines as short as possible and enclose as much of them as possible in metal conduit or equivalent shielding. There should be a good electrical contact between this conduit and ground (Earth).
2. Keep the work and electrode leads as short as possible. Tape the leads together where practical.
3. Be sure the torch and earth leads rubber coverings are free from cuts and cracks that allow welding power leakage
4. Keep earth lead connection to work in good condition – Clean area on workbench where earth clamp is situated on a regular basis.

Electrical installation cont.

Input Connections

Make sure the voltage, phase and frequency of input power is as specified on machine rating plate located at rear of machine.

Have a qualified electrician provide suitable input power as per national electrical codes. Make sure machine is earthed / grounded.

Make sure fuse or circuit breaker is correct rating for machine. Using fuses or circuit breakers smaller than recommended will result in 'nuisance' shut off from welder inrush currents even if welding at low amperages.

Failure to follow these instructions can cause immediate failure within the welder and void machines warranty.

Turn the input power OFF at the mains switch & fuse box before working on this equipment. Have a qualified electrician install & service this equipment.

Allow machine to sit for 5 minutes minimum to allow the power capacitors to discharge before working inside this equipment. Do not touch electrically live parts

The MIG251 Digital MIG Welder requires a 240V 50/60Hz supply. It requires a 32A supply. It comes with a 2.5 metre mains cable attached.

Connect wires according to national coding.

Brown wire – Live

Blue wire – Neutral

Green/Yellow Wire – Earth (Ground)

Connecting to an Engine Driven Generator

If connecting this machine to an engine driven generator please ensure the following
Minimum Generator KVA Output – 7.0 KVA continuous Generator to be fitted with AVR
(automatic voltage regulation) DO NOT USE ON A GENERATOR WITHOUT AVR

Connecting to a generator without the above minimum requirements
will invalidate your warranty.

Technical specifications

Input	240V AC 50/60Hz	Input amperage 32A
Gross weight	20 KG	
Dimensions	600L x 270W x 480H (mm)	
Insulation	IP21S	
MIG	Current range MIG	30A - 250A
	No load voltage	80VDC
	Duty cycle	35% @ 250A
	Trigger modes Manual mode	2T,4T
MIG EASY SET	Wire diameter	0.6, 0.8, 1.0mm
	Material thickness selector	0.8, 1.0, 1.5, 2.0, 3.0, 4.0, 5.0, 6.0, 8mm
MIG Manual mode	Welding voltage	13.0 - 27V
	Wire feed speed	1.5 - 15.0 m/min
	Spool gun option	Yes
	Burnback control	0.0s - 2.0s
	Wire diameter	0.6, 0.8, 1.0mm
MMA EASY SET	Electrode size	2.5, 3.2, 4.0mm
	Electrode type	6013, 7018
	Material thickness	1.5 - 10.0mm (See page 19)
MMA Manual mode	Amperage range	20 - 200A
	Electrodes	Mild / Stainless Steel / Dissimilar

Connections

Front panel connections

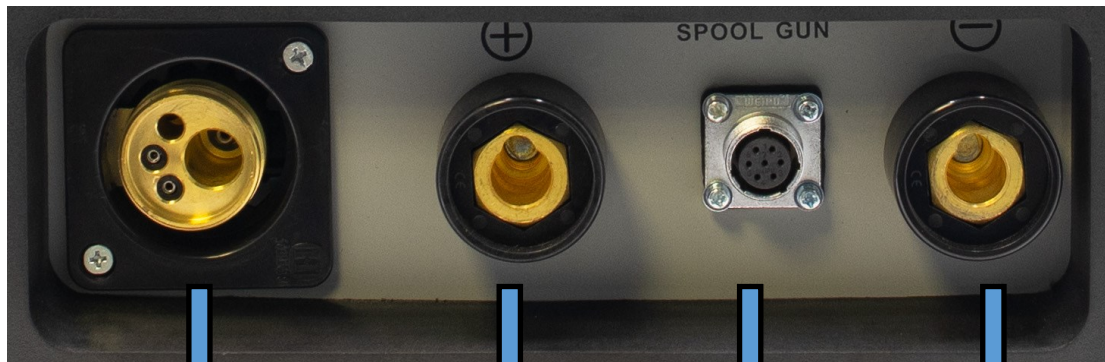

MIG mode + positive
connector for earth
lead for **gasless flux
cored wire only.**

MMA mode - connect
electrode holder.

7 pin socket for
spool on gun.

MIG mode - connect
earth lead (negative)
when welding with
GAS.

MMA mode - connect
Earth lead

Euro torch connector. Connect Euro type MIG torch to euro torch connector, align torch connector to machine connector and then turn retaining ring clockwise to secure. Ensure torch is secured tightly to avoid weld power problems

Rear panel connections cont..

Gas connector & Extra earth connection

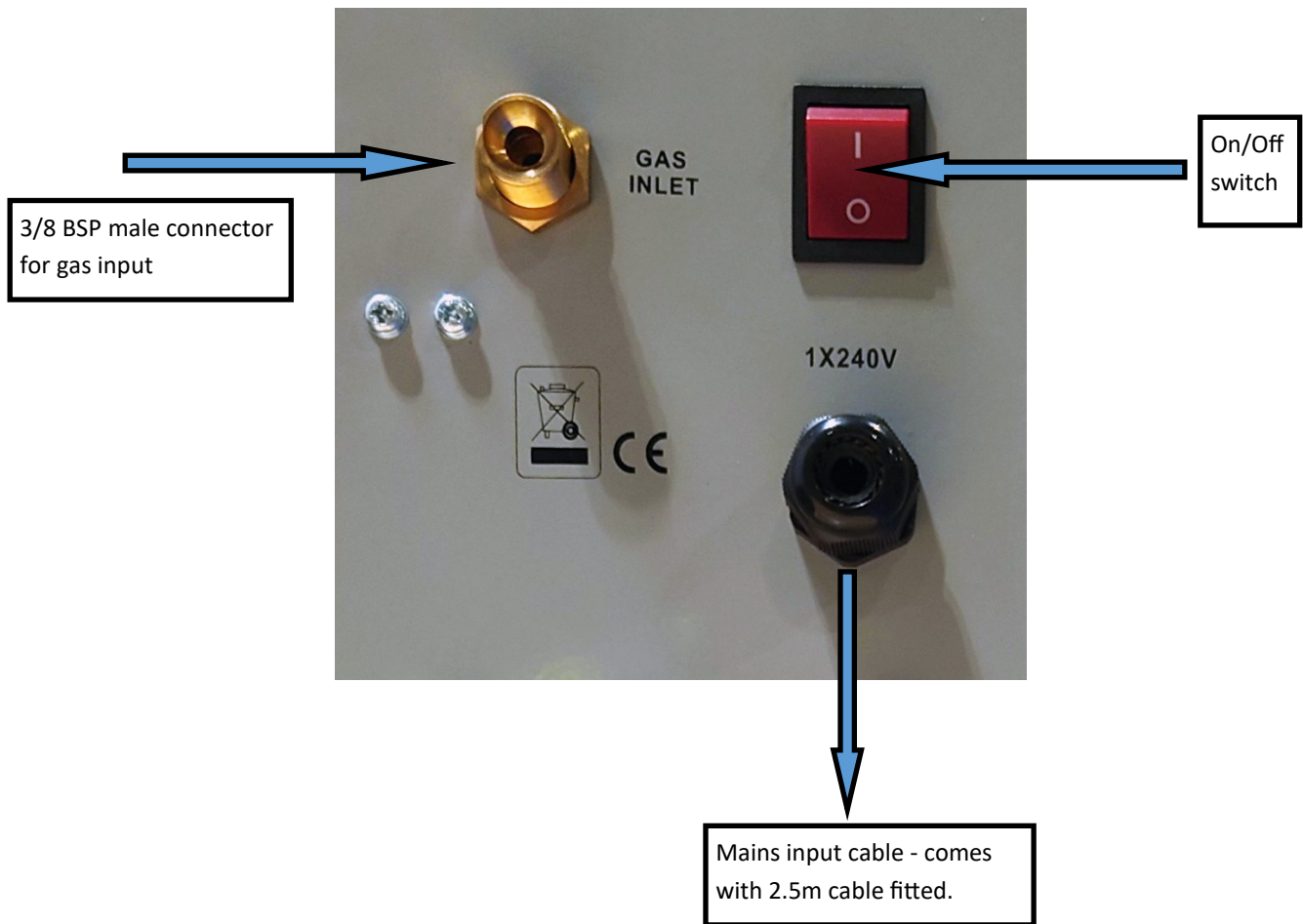

Extra earth connection, used if you experience local interference (not normally used)

Wire feed assembly, wire reel holder & gasless wire

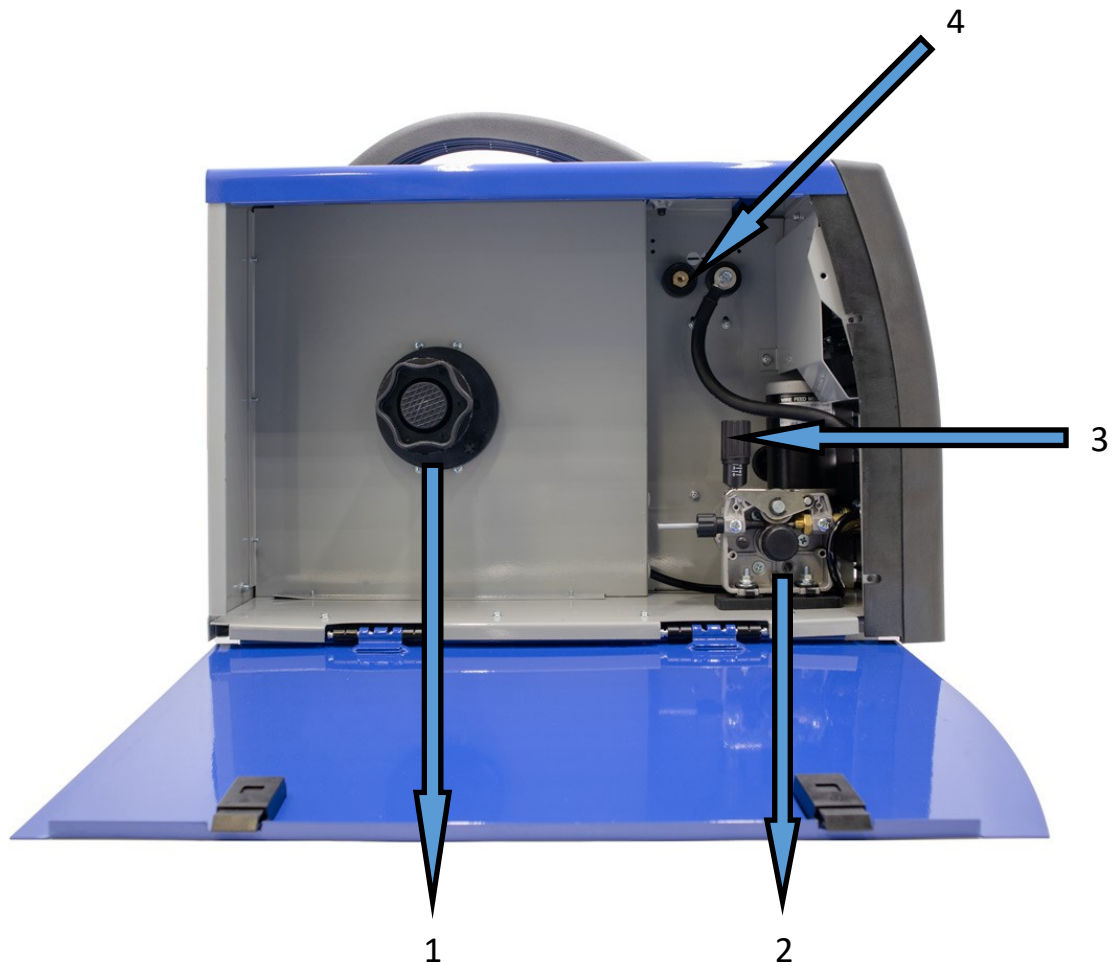

1 - Wire reel retainer. Screw in to retain wire roll adaptor onto wire reel.

2 - Wire Feed Drive Assembly. To change roller size release retaining screw, remove roller and turn roller around and slide onto shaft making sure the right size groove is in line with wire and refit retaining screw. The MIG251 comes fitted with a dual rollers 0.6/0.8mm & 0.8/1.0mm.

3 - Roller tensioner - This sets the pressure of rollers, the best way to adjust tension is to slacken off pressure so that MIG welding wire does not feed, slowly adjust pressure until wire feeds smoothly, you should be able to stop wire feeding by holding wire and it should slip on rollers. If you have too little pressure wire will slip when welding causing unwanted Burn back into tips or erratic weld beads size.

4 - When using gasless wire, move internal cable to negative connector – This then makes the torch negative, you would then connect Workpiece earth lead to + positive connector on front of machine

Front panel

Digital Colour Screen with easy to navigate menu system
EASY SET mode - pre-programmed weld settings MIG & MMA

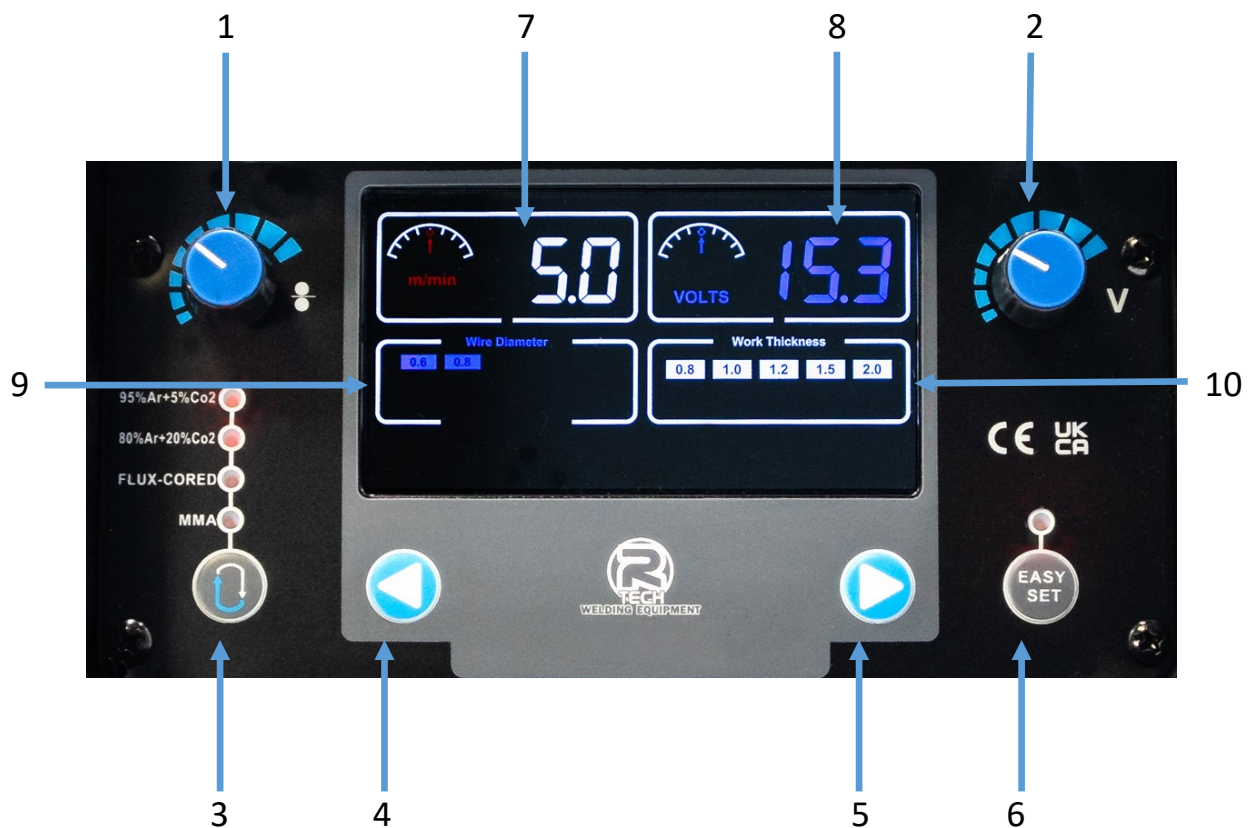

1 - Wire feed speed - Turn to change setting in small steps, press and turn to change in larger steps

2 - Welding voltage - Turn to change setting in small steps, press and turn to change in larger steps

3 - SELECT button - Press to cycle through four welding modes

4 - Left arrow button - use to scroll left in menus

5 - Right arrow button - use to scroll left in menus

6 - EASY SET button - press to enable / disable EASY SET mode

7 - Wire feed speed display

8 - Welding voltage display

9 - Wire diameter display - EASY SET

10 - Work thickness display - EASY SET

Controls and settings

The MIG251 features 4 main operating modes

MIG in EASY mode

MIG in Manual mode

MMA (STICK) in EASY mode

MMA (STICK) in Manual mode

MIG EASY MODE - With gas

R-Tech Easy mode takes the guesswork out of MIG welding. You normally had to enter wire speed and welding voltage to weld on manual welders, we have done this for you.

You simply select the following from easy to understand screen.

Wire diameter

Material thickness

The machine will set main welding voltage and wire feed speed

Press select button to required gas being used 95% Arg/Co2 or 20% Arg/Co2

TO ENTER EASY MODE - PRESS EASY SET BUTTON ON FRONT PANEL

Press left arrow to switch between 0.6mm, 0.8mm and 1.0mm wire diameter, the selected size will flash

Now press right arrow to switch between material thickness, the selected size will flash

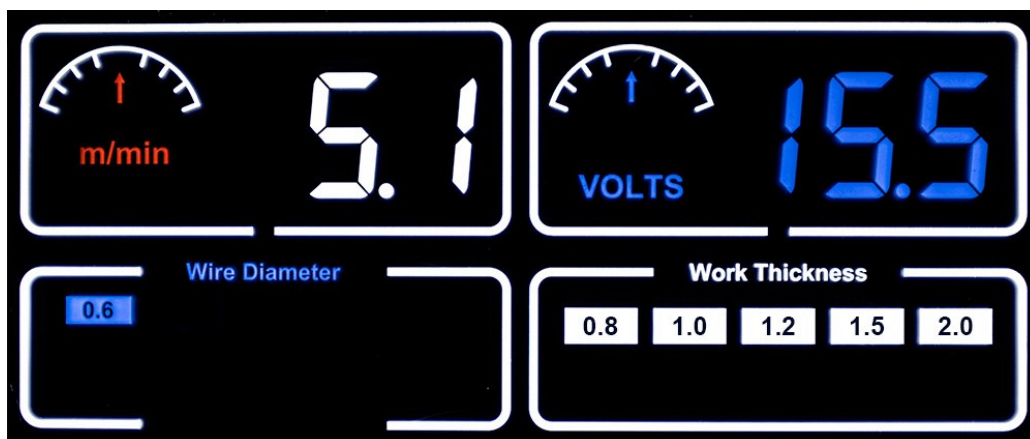

EASY SET MIG 0.6mm wire

The above image shows 0.6mm wire selected, you then have material thickness options of 0.8mm, 1.0mm, 1.2mm, 1.5mm, 2.0mm

EASY SET MIG 0.6mm continued

Once you have selected 0.6mm wire size and material thickness the suggested wire speed and voltage will be shown in the display, you are now ready to weld.

If you want to fine tune the weld characteristics to suit your personal preference.

You can trim the wire speed by 1 m/min by turning wire speed knob.

You can trim the welding voltage by +/- 1V by turning welding voltage knob.

EASY SET MIG 0.8mm wire

The above image below shows 0.8mm wire selected, you then have material thickness options of 0.8mm, 1.0mm, 1.5mm, 2.0mm, 2.5mm, 3.0mm, 3.5mm and 4.0mm

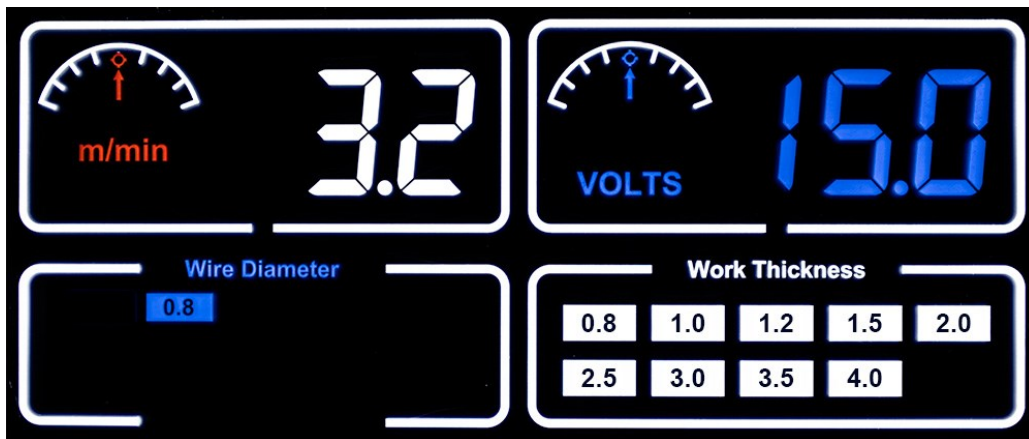

Once you have selected 0.8mm wire size and material thickness the suggested wire speed and voltage will be shown in the display, you are now ready to weld.

If you want to fine tune the weld characteristics to suit your personal preference.

You can trim the wire speed by 1 m/min by turning wire speed knob.

You can trim the welding voltage by 1V by turning welding voltage knob.

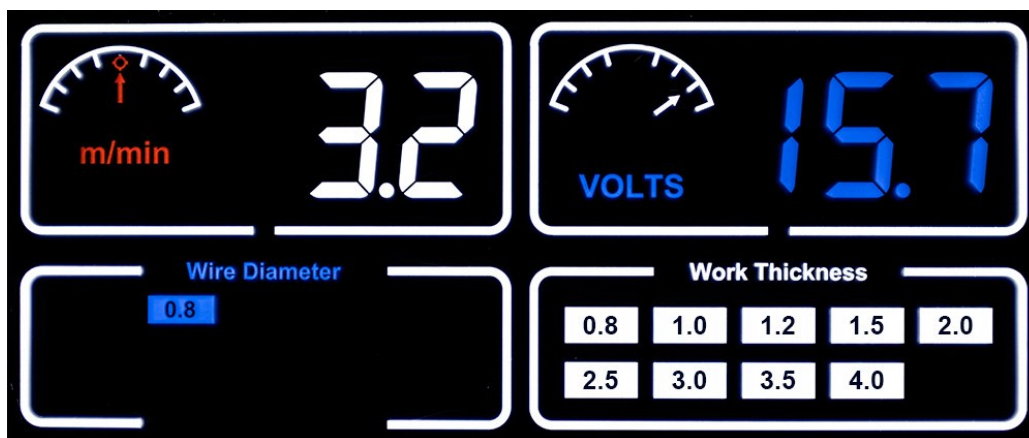

EASY SET MIG 1.0mm wire

With 1.0mm wire selected, you then have material thickness options of 1.5mm, 2.0mm, 3.0mm, 4.0mm, 5.0mm, 6.0mm, 8.0mm

MIG EASY MODE - Gasless wire (Flux cored)

Press select button to Flux-Cored indicator.

TO ENTER EASY MODE - PRESS EASY SET BUTTON ON FRONT PANEL

Press left arrow to switch between 0.8mm,0.9mm & 1.0mm wire diameter, the selected size will flash

Now press right arrow to switch between material thickness, the selected size will flash



Once you have selected wire size and material thickness the suggested wire speed and voltage will be shown in the display, you are now ready to weld.

Material thickness options of 0.8mm wire

1.0mm, 1.5mm, 2.0mm, 3.0mm and 4.0mm

If you want to fine tune the weld characteristics to suit your personal preference.

You can trim the wire speed by 1 m/min by turning wire speed knob.

You can trim the welding voltage by +/- 1V by turning welding voltage knob.

Material thickness options of 0.9mm wire

1.5mm, 2.0mm, 3.0mm, 4.0mm and 5.0mm

Material thickness options of 1.0mm wire

1.5mm, 2.0mm, 3.0mm, 4.0mm, 5.0mm, 6.0mm,8.0mm

MIG Manual mode

In manual MIG mode you have full control of welding wire feed speed, welding voltage, 2T/4T trigger options, Burnback control and spool on gun operation.

Use select button to select 95% ARG Mode, ensure EASY SET is off, the following screen will be shown.

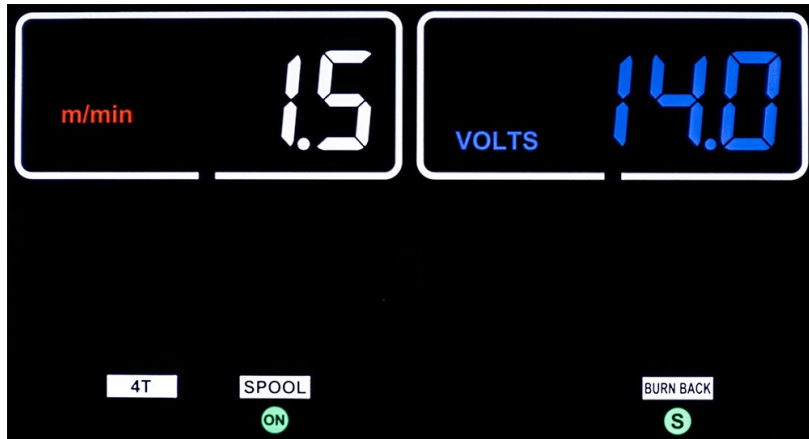

Set wire feed speed using left side knob, adjustable between 1.5 - 15 m/min.

Set welding voltage using right side knob, adjustable between 13v - 27v.

2T & 4T Trigger control

You can select between 2T and 4T trigger options by pressing left or right arrow buttons until 4T is flashing, then use left knob to turn from off/on.

2T - Press trigger to start weld, release to finish weld.

4T - Press and release trigger to start weld, To finish weld press and release trigger.
This is commonly know as trigger latching.

Burnback control

Burnback is how long the welding power will continue after wire feed has stopped, this stops the wire from sticking to workpiece when weld finished, if Burnback is set too long you can experience wire burning back to tip.

You can adjust Burnback by pressing left or right arrow buttons until Burnback is flashing, then use left knob to adjust from 0s to 2.0s

For most applications a setting of 0.3s is advised.

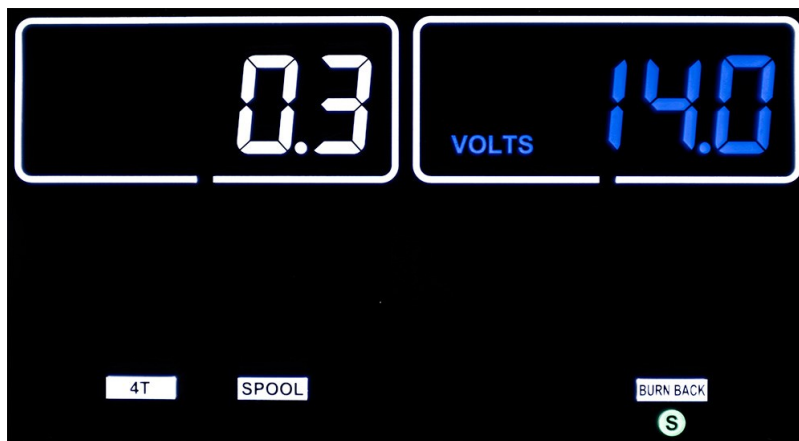

Spool on Gun option

For best results when welding aluminium we recommended using a spool on gun as shown in image below

You can select spool gun function by pressing left or right arrow buttons until SPOOL is flashing, then use left knob to switch from off/on. When switched on the internal wire feed is disabled.

Disconnect standard MIG torch and connect spool gun to euro connector and 7 pin plug to machine

Note: Pure argon is required when welding aluminium.



MMA (STICK) EASY

R-Tech EASY SET mode takes the guesswork out of MMA welding. You normally had to enter required amperage to weld on manual welders, we have done this for you.

You simply select the following from the easy to understand screen.

Electrode Type 6013 or 7018

Electrode diameter

Material thickness

The machine will set main welding amperage required.

Press select button so MMA mode is illuminated.

TO ENTER EASY MODE - PRESS EASY SET BUTTON ON FRONT PANEL

Press left arrow to switch between electrode type and electrode size, the selected electrode type and size will flash.

Now press right arrow to switch between material thickness, the selected size will flash.

Once you have selected electrode type and size and material thickness, the required welding amperage will show in display as image below. You are now ready to weld.

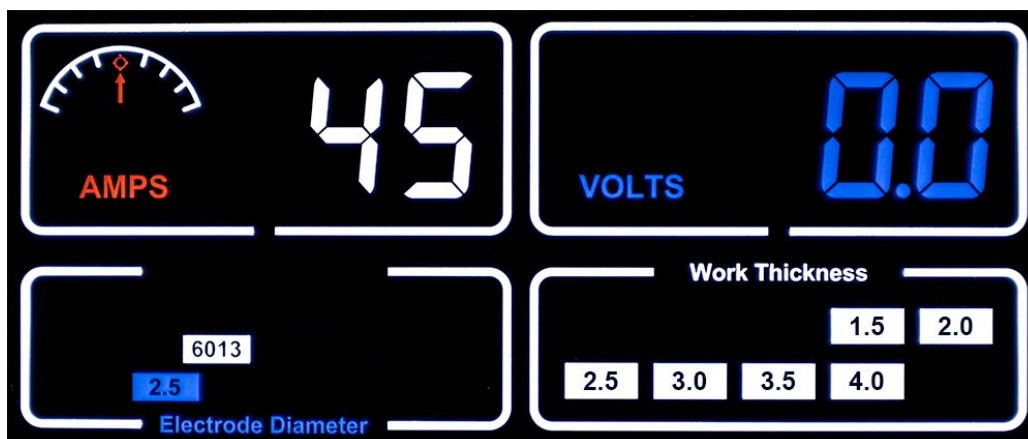

You can trim the welding amperage by using left control knob +/- 10 amps to suit your personal welding travel speed / weld bead.

MMA (STICK) EASY cont..

Note: When in MMA mode the welding terminals are constantly LIVE.

Ensure electrode / electrode holder are not touching workpiece / earth when switching to MMA mode.

MMA EASY SET SETTINGS.

Electrode Type	Electrode Size	Material thickness
6013	2.5mm	1.5, 2.0, 2.5, 3.0, 3.5, 4.0, 5.0mm
6013	3.2mm	3.0, 4.0, 5.0, 6.0, 8.0mm
6013	4.0mm	4.0, 5.0, 6.0, 8.0, 10mm
7018	2.5mm	3.0, 4.0, 5.0, 6.0mm
7018	3.2mm	4.0, 5.0, 6.0, 8.0mm
7018	4.0mm	5.0, 6.0, 8.0, 10mm

Image below shows 6013, 3.2mm electrode with 3.0mm material thickness selected and using left control knob the welding amperage has been increased from 80A to 87A using trim function as indicated by arrow.

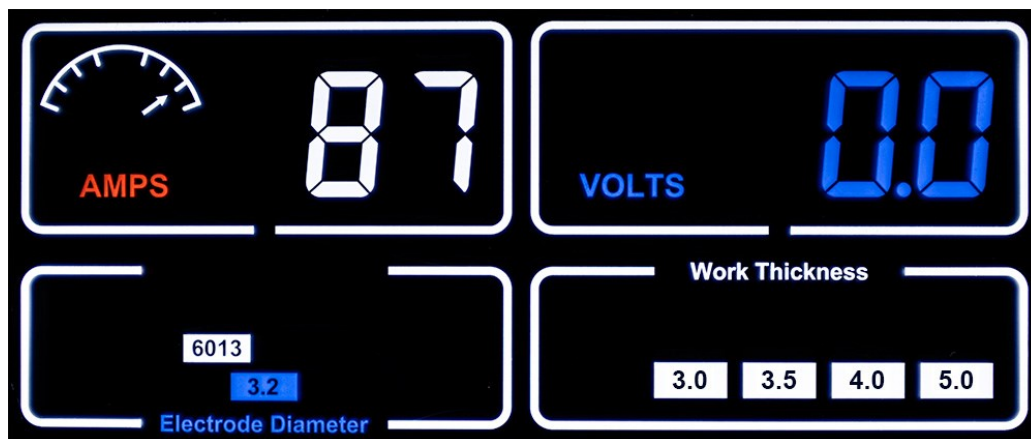

MMA (STICK) Manual mode

Note: When in MMA mode the welding terminals are constantly LIVE.

Ensure electrode / electrode holder are not touching workpiece / earth when switching to MMA mode.

To enter MMA manual mode, use select button to move indicator to MMA then ensure EASY SET is turned off. You will see the following screen.

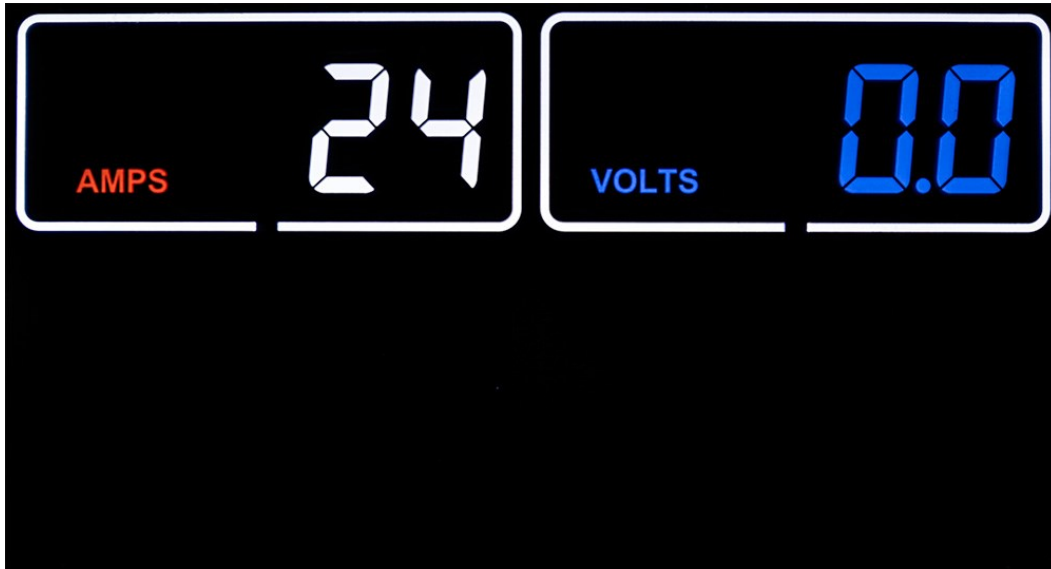

To change welding amperage use left side control knob to required amperage.

Range is 20 - 200 amps.

Troubleshooting

No output - Display is not lit

Check machine on/off switch is in the 'on' position

Check Input power to machine

Check plug wiring

Check mains trip / fuses

No output - Fan runs - Display is lit

Check torch connections are secure and torch switch operation, try replacing MIG torch.

No output – display is lit – Gas at torch tip – No wire feed

Check machine is not in SPOOL GUN mode if using standard MIG mode

Porosity in weld – No / low gas at torch tip

Check gas supply from gas bottle, check flow rate on regulator, check gas hose for restrictions, check for draughts in local area, open doors etc. Replace MIG torch – it may have gas restriction.

Poor weld penetration

Check condition of earth lead and clamp and ensure clamp is connecting to a clean area on work piece.

Check the condition of the MIG torch, try another MIG torch.

Please contact our technical support via LIVECHAT on website or call 01452 733933 to speak to one of our experienced and friendly engineers who will assist you with any technical issues.

			
WARNING	<ul style="list-style-type: none"> Do not touch electrically live parts or electrode with skin or wet clothing. Insulate yourself from work and ground. 	<ul style="list-style-type: none"> Keep flammable materials away. 	<ul style="list-style-type: none"> Wear eye, ear and body protection.
Spanish AVISO DE PRECAUCION	<ul style="list-style-type: none"> No toque las partes o los electrodos bajo carga con la piel o ropa mojada. Aíslese del trabajo y de la tierra. 	<ul style="list-style-type: none"> Mantenga el material combustible fuera del área de trabajo. 	<ul style="list-style-type: none"> Protéjase los ojos, los oídos y el cuerpo.
French ATTENTION	<ul style="list-style-type: none"> Ne laissez ni la peau ni des vêtements mouillés entrer en contact avec des pièces sous tension. Isolez-vous du travail et de la terre. 	<ul style="list-style-type: none"> Gardez à l'écart de tout matériel inflammable. 	<ul style="list-style-type: none"> Protégez vos yeux, vos oreilles et votre corps.
German WARNUNG	<ul style="list-style-type: none"> Berühren Sie keine stromführenden Teile oder Elektroden mit Ihrem Körper oder feuchter Kleidung! Isolieren Sie sich von den Elektroden und dem Erdboden! 	<ul style="list-style-type: none"> Entfernen Sie brennbares Material! 	<ul style="list-style-type: none"> Tragen Sie Augen-, Ohren- und Körperschutz!
Portuguese ATENÇÃO	<ul style="list-style-type: none"> Não toque partes elétricas e electrodos com a pele ou roupa molhada. Isole-se da peça e terra. 	<ul style="list-style-type: none"> Mantenha inflamáveis bem guardados. 	<ul style="list-style-type: none"> Use proteção para a vista, ouvido e corpo.
Japanese 注意事項	<ul style="list-style-type: none"> 通電中の電気部品、又は溶材にヒフやぬれた布で触れないこと。 施工物やアースから身体が絶縁されている様にして下さい。 	<ul style="list-style-type: none"> 燃えやすいものの側での溶接作業は絶対にしてはなりません。 	<ul style="list-style-type: none"> 目、耳及び身体に保護具をして下さい。
Chinese 警告	<ul style="list-style-type: none"> 皮肤或湿衣物切勿接触带电部件及焊缝。 使你自已离地面和工件绝缘。 	<ul style="list-style-type: none"> 把一切易燃物品移离工作场所。 	<ul style="list-style-type: none"> 佩戴眼、耳及身体劳动保护用具。
Korean 위험	<ul style="list-style-type: none"> 전도체나 용접봉을 젖은 행걸 또는 피부로 절대 접촉치 마십시오. 모재외 접지를 접촉치 마십시오. 	<ul style="list-style-type: none"> 인화성 물질을 접근 시키지 마십시오. 	<ul style="list-style-type: none"> 눈, 귀와 몸에 보호장구를 착용하십시오.
Arabic تحذير	<ul style="list-style-type: none"> لا تلمس الأجزاء التي يسري فيها التيار الكهربائي أو الألكترود بجند الجسم أو بالمعالم المبللة بالماء. ضع عازلا على جسمك خلال العمل. 	<ul style="list-style-type: none"> ضع المواد القابلة للاشتعال في مكان بعيد. 	<ul style="list-style-type: none"> ضع أدوات وملابس واقية على عينيك وأذنيك وجسمك.

READ AND UNDERSTAND THE MANUFACTURER'S INSTRUCTION FOR THIS EQUIPMENT AND THE CONSUMABLES TO BE USED AND FOLLOW YOUR EMPLOYER'S SAFETY PRACTICES.

SE RECOMIENDA LEER Y ENTENDER LAS INSTRUCCIONES DEL FABRICANTE PARA EL USO DE ESTE EQUIPO Y LOS CONSUMIBLES QUE VA A UTILIZAR, SIGA LAS MEDIDAS DE SEGURIDAD DE SU SUPERVISOR.

LISEZ ET COMPRENEZ LES INSTRUCTIONS DU FABRICANT EN CE QUI REGARDE CET EQUIPMENT ET LES PRODUITS A ETRE EMPLOYES ET SUIVEZ LES PROCEDURES DE SECURITE DE VOTRE EMPLOYEUR.

LESEN SIE UND BEFOLGEN SIE DIE BETRIEBSANLEITUNG DER ANLAGE UND DEN ELEKTRODENEINSATZ DES HERSTELLERS. DIE UNFALLVERHÜTUNGSVORSCHRIFTEN DES ARBEITGEBERS SIND EBENFALLS ZU BEACHTEN.

			
<ul style="list-style-type: none"> ● Keep your head out of fumes. ● Use ventilation or exhaust to remove fumes from breathing zone. 	<ul style="list-style-type: none"> ● Turn power off before servicing. 	<ul style="list-style-type: none"> ● Do not operate with panel open or guards off. 	WARNING
<ul style="list-style-type: none"> ● Los humos fuera de la zona de respiración. ● Mantenga la cabeza fuera de los humos. Utilice ventilación o aspiración para gases. 	<ul style="list-style-type: none"> ● Desconectar el cable de alimentación de poder de la máquina antes de iniciar cualquier servicio. 	<ul style="list-style-type: none"> ● No operar con panel abierto o guardas quitadas. 	Spanish AVISO DE PRECAUCION
<ul style="list-style-type: none"> ● Gardez la tête à l'écart des fumées. ● Utilisez un ventilateur ou un aspirateur pour ôter les fumées des zones de travail. 	<ul style="list-style-type: none"> ● Débranchez le courant avant l'entretien. 	<ul style="list-style-type: none"> ● N'opérez pas avec les panneaux ouverts ou avec les dispositifs de protection enlevés. 	French ATTENTION
<ul style="list-style-type: none"> ● Vermeiden Sie das Einatmen von Schweißrauch! ● Sorgen Sie für gute Be- und Entlüftung des Arbeitsplatzes! 	<ul style="list-style-type: none"> ● Strom vor Wartungsarbeiten abschalten! (Netzstrom völlig öffnen; Maschine anhalten!) 	<ul style="list-style-type: none"> ● Anlage nie ohne Schutzgehäuse oder Innenschutzverkleidung in Betrieb setzen! 	German WARNUNG
<ul style="list-style-type: none"> ● Mantenha seu rosto da fumaça. ● Use ventilação e exaustão para remover fumo da zona respiratória. 	<ul style="list-style-type: none"> ● Não opere com as tampas removidas. ● Desligue a corrente antes de fazer serviço. ● Não toque as partes elétricas nuas. 	<ul style="list-style-type: none"> ● Mantenha-se afastado das partes moventes. ● Não opere com os painéis abertos ou guardas removidas. 	Portuguese ATENÇÃO
<ul style="list-style-type: none"> ● ヒュームから顔を離すようにして下さい。 ● 換気や排煙に十分留意して下さい。 	<ul style="list-style-type: none"> ● メンテナンス・サービスに取りかかる際には、まず電源スイッチを必ず切って下さい。 	<ul style="list-style-type: none"> ● パネルやカバーを取り外したまま機械操作をしないで下さい。 	Japanese 注意事項
<ul style="list-style-type: none"> ● 頭部遠離煙霧。 ● 在呼吸區使用通風或排風器除煙。 	<ul style="list-style-type: none"> ● 維修前切斷電源。 	<ul style="list-style-type: none"> ● 氣表板打開或沒有安全罩時不準作業。 	Chinese 警告
<ul style="list-style-type: none"> ● 얼굴로부터 용접가스를 멀리하십시오. ● 호흡지역으로부터 용접가스를 제거하기 위해 가스제거기나 통풍기를 사용하십시오. 	<ul style="list-style-type: none"> ● 보수전에 전원을 차단하십시오. 	<ul style="list-style-type: none"> ● 판넬이 열린 상태로 작동치 마십시오. 	Korean 위험
<ul style="list-style-type: none"> ● ابتعد رأسك بعيداً عن الدخان. ● استعمل التهوية أو جهاز ضغط الدخان للخارج لكي تبعد الدخان عن المنطقة التي تتنفس فيها. 	<ul style="list-style-type: none"> ● أقطع التيار الكهربائي قبل القيام بأية صيانة. 	<ul style="list-style-type: none"> ● لا تشغيل هذا الجهاز إذا كانت الإغطية الحديدية الواقية ليست عليه. 	Arabic تحذير

LEIA E COMPREENDA AS INSTRUÇÕES DO FABRICANTE PARA ESTE EQUIPAMENTO E AS PARTES DE USO, E SIGA AS PRÁTICAS DE SEGURANÇA DO EMPREGADOR.

使う機械や溶材のメーカーの指示書をよく読み、まず理解して下さい。そして貴社の安全規定に従って下さい。

請詳細閱讀並理解製造廠提供的說明以及應該使用的銀焊材料，並請遵守貴方的有關勞動保護規定。

이 제품에 동봉된 작업지침서를 숙지하시고 귀사의 작업자 안전수칙을 준수하시기 바랍니다.

اقرأ بتمعن وافهم تعليمات المصنع المنتج لهذه المعدات والمواد قبل استعمالها واتبع تعليمات الوقاية لصاحب العمل.